



For more Hi-Fi manuals and set-up information
please visit www.hifiengine.com

PRINTED CIRCUIT BOARD (Pattern Side)

**PRE DRIVE
C. BOARD
NA07785: A,B,G,R
NA07786: U,C**

**To PJ & VR
C. BOARD (1/4)**

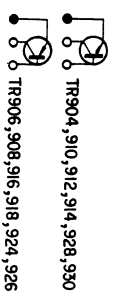
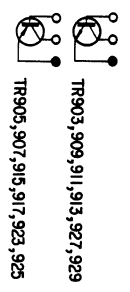
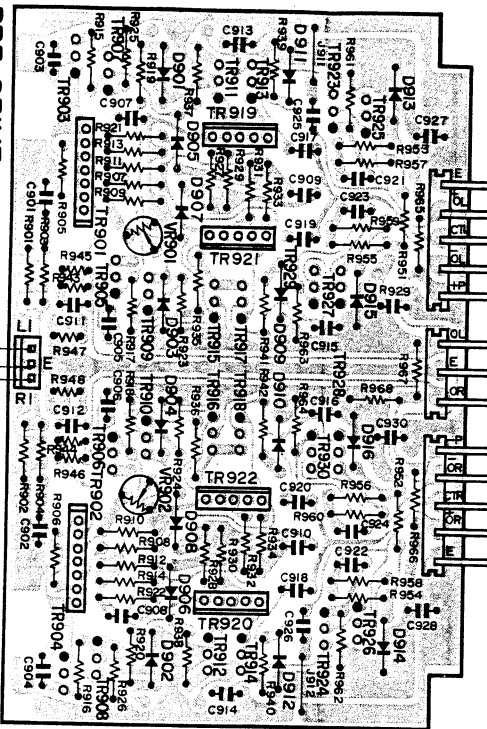

**PJ & VR
C. BOARD
(3/4)**

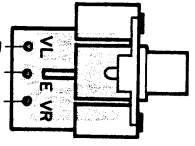

INPUT

To PJ & VR C. BOARD (2/4)

**To PJ & VR
C. BOARD (1/4)**

**To ELECTROLYTIC
CAP C. BOARD**

GND

SPEAKERS

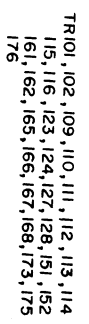
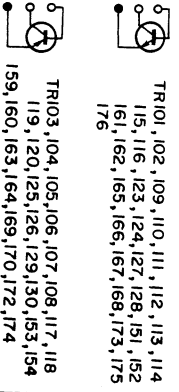
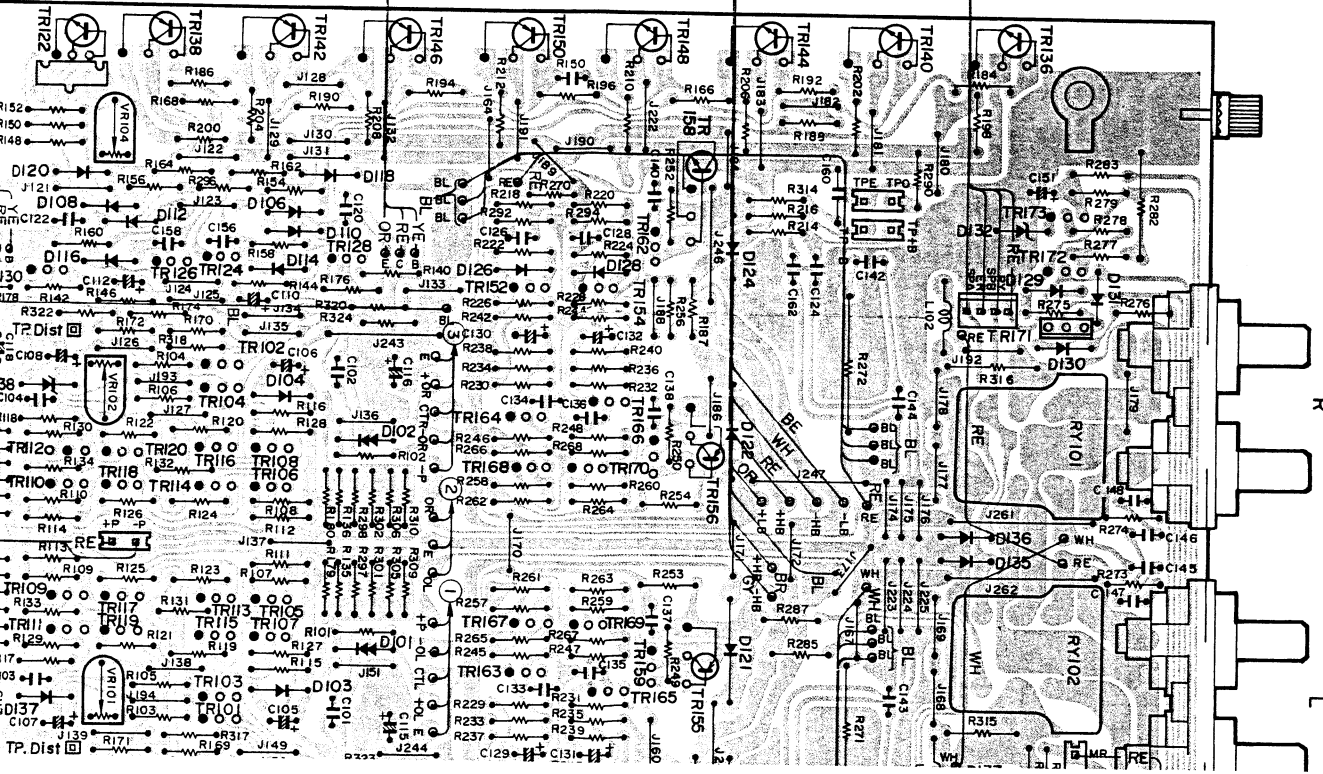

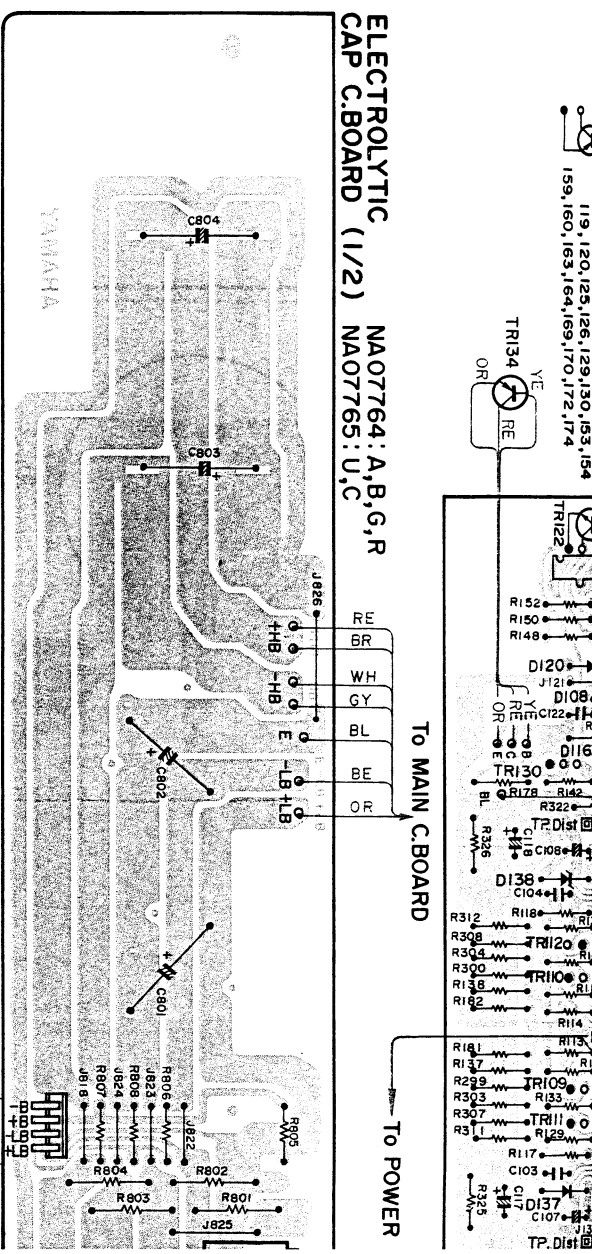
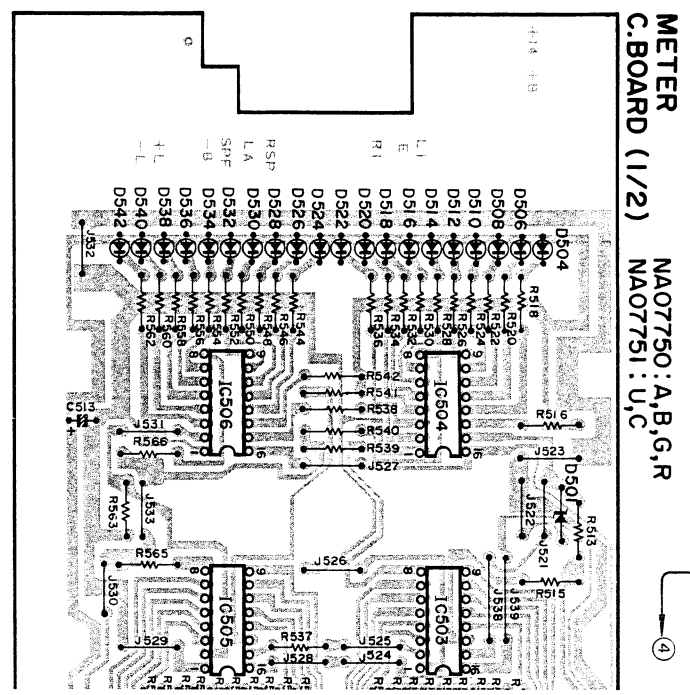
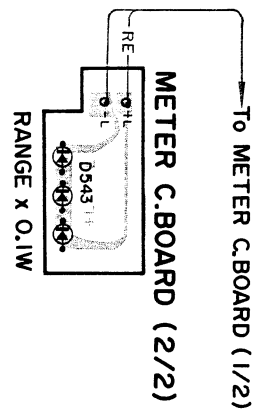
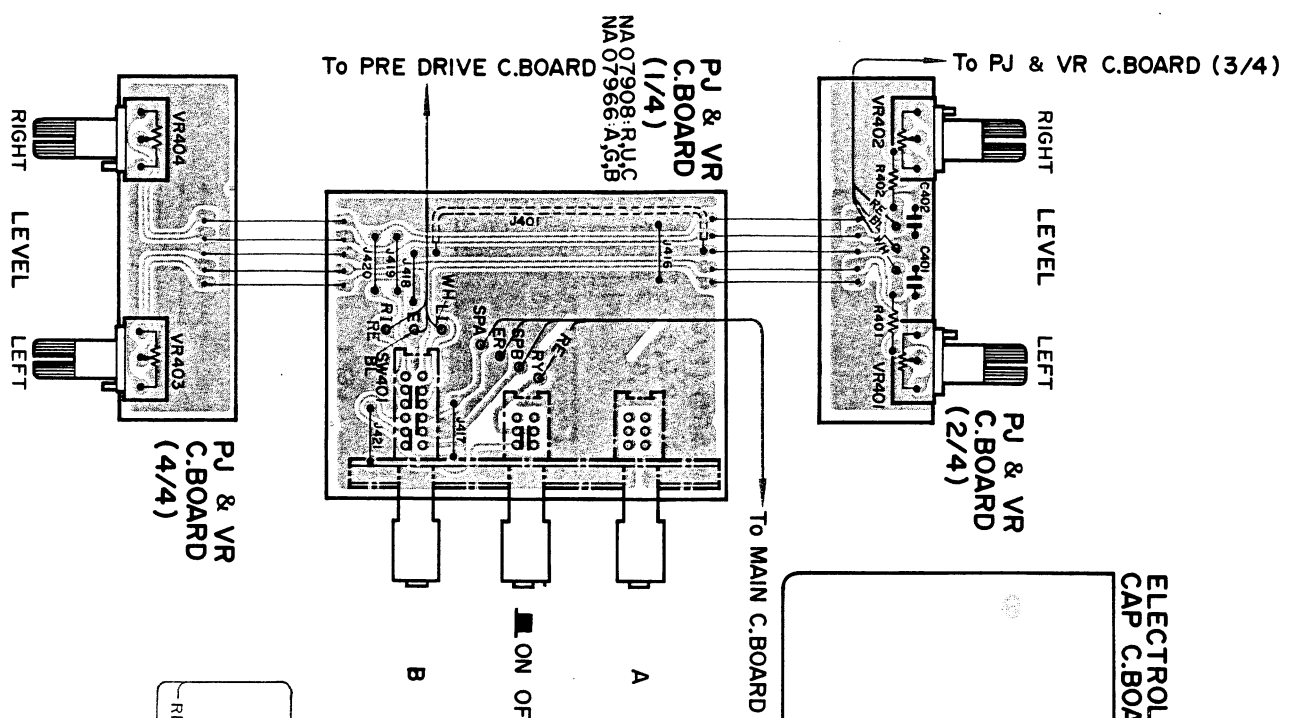

(de)

PJ & VR
C. BOARD
(3/4)

2, 914, 924, 930
6, 918, 924, 926

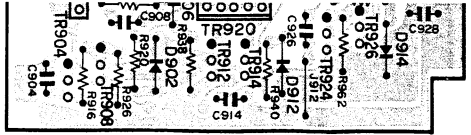

TR101, 102, 109, 110, 111, 112, 113, 114
115, 116, 123, 124, 127, 128, 151, 152
161, 162, 165, 166, 167, 168, 173, 175
176

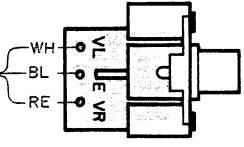

INPUT

To PJ & VR C. BOARD (2/4)

To PJ & VR
C. BOARD (1/4)

To ELECTROLYTIC
CAP C. BOARD

GND

SPEAKERS

U, C - MODELS

MAIN C. BOARD
NA07753 : A, B, G, R
NA07754 : U, C

To POWER C. BOARD

To METER C. BOARD (1/2)

- U.....USA
- C.....Canadian
- G.....European
- A.....Australian
- B.....British
- R.....General

CONTROL
C. BOARD
(1/2)
NA07772
: U, C

To UNSWICED

CONTROL C. BOARD (2)

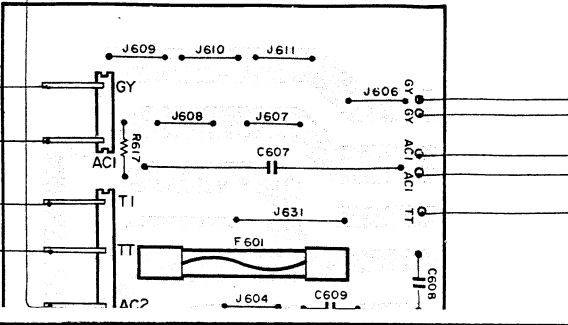
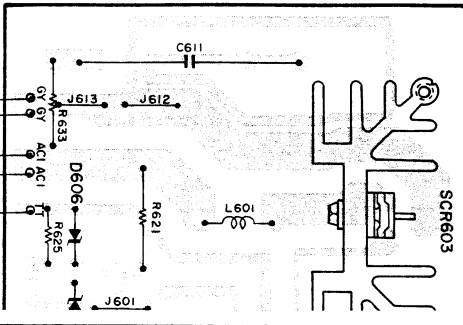

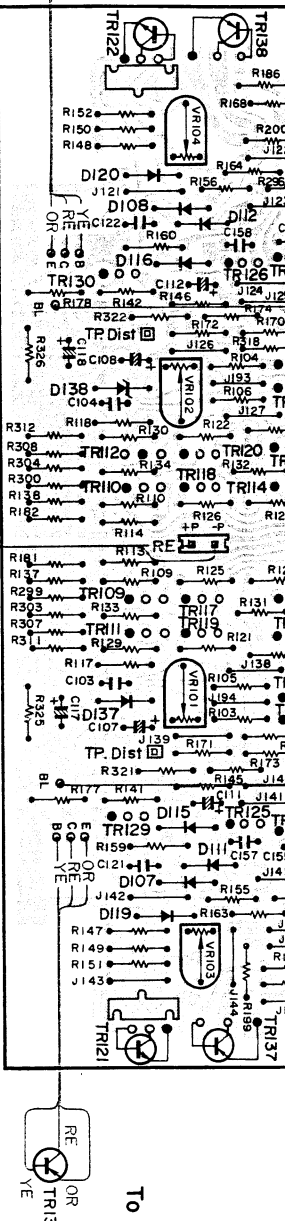
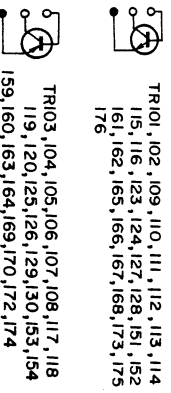

TR101, 102, 109, 110, 111, 112, 113, 114
115, 116, 123, 124, 127, 128, 151, 152
161, 162, 165, 166, 167, 168, 173, 175
176

TR103, 104, 105, 106, 107, 108, 117, 118
119, 120, 125, 126, 129, 130, 153, 154
159, 160, 163, 164, 169, 170, 172, 174

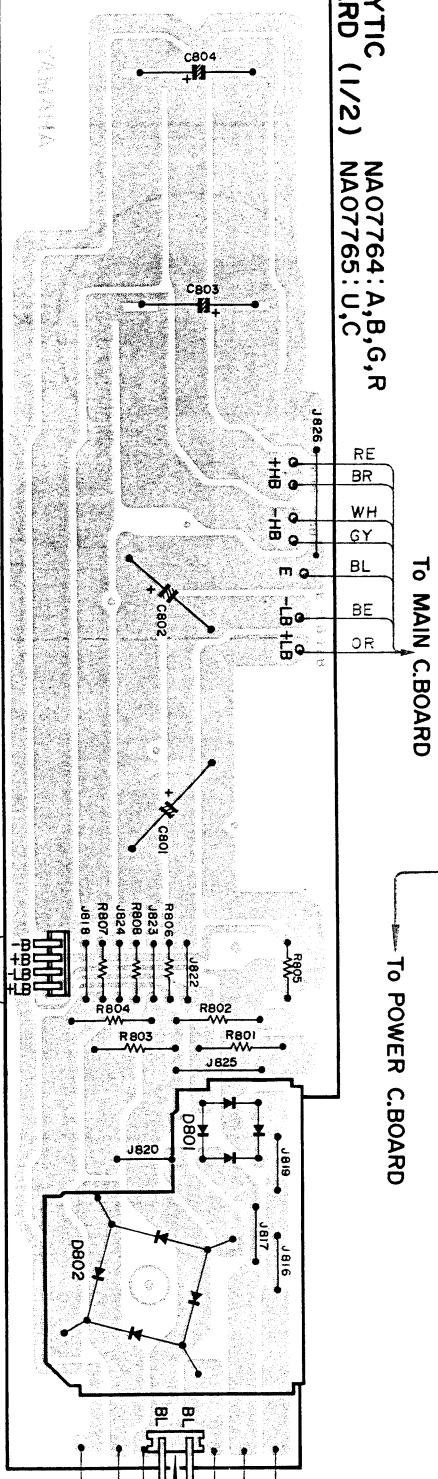

NA07764: A, B, G, R
NA07765: U, C

NA07750: A, B, G, R
NA07751: U, C

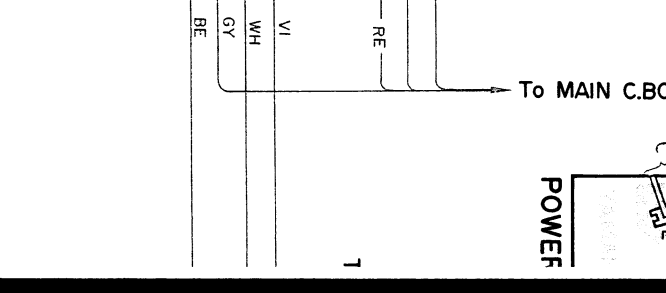
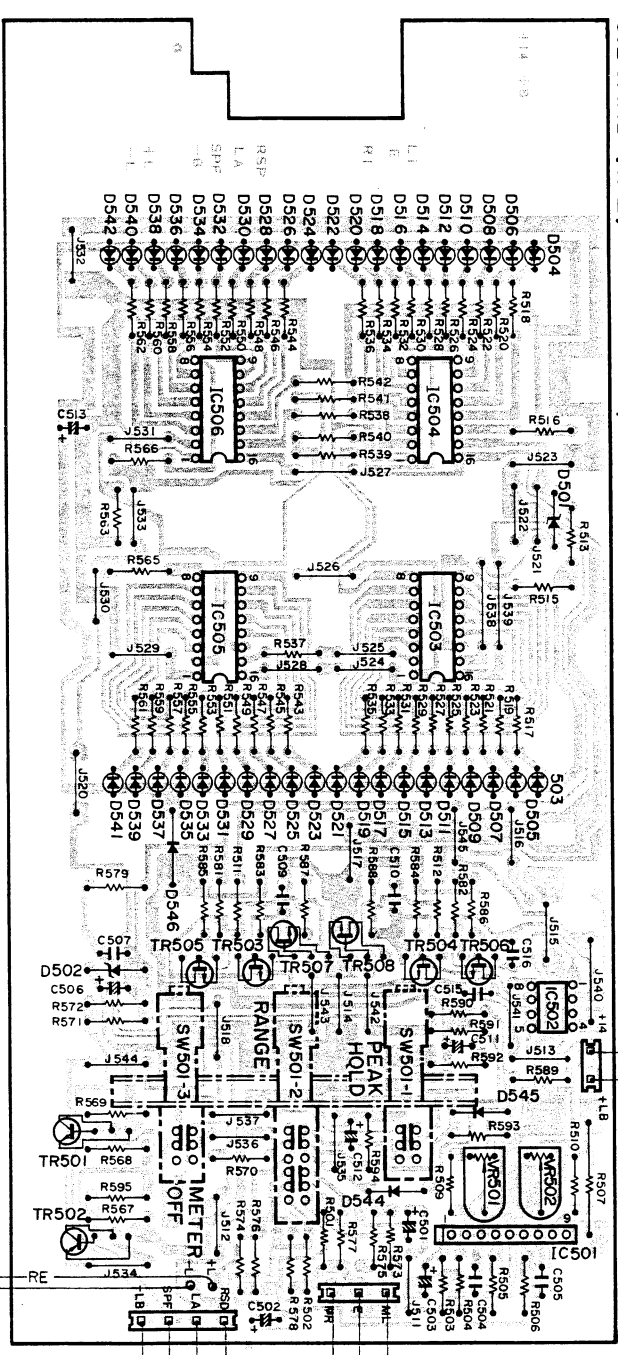
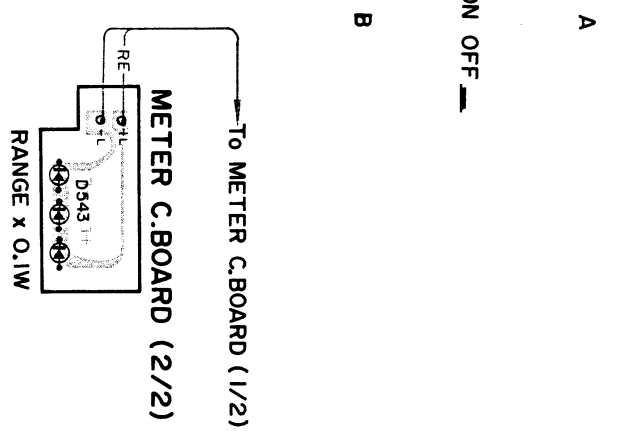

ELECTROLYTIC CAP C. BOARD (2/2)

To METER C. BOARD (1/2)

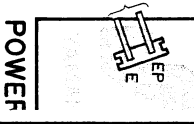

To POWER TRANSFORMER

To POWER SW

To TRANSFORMER

To POWER SW

- LS
 :USA
 :Canada
 :European
 :Australian
 :British
 :General

To POWER C.BOARD
 To METER C.BOARD (1/2)

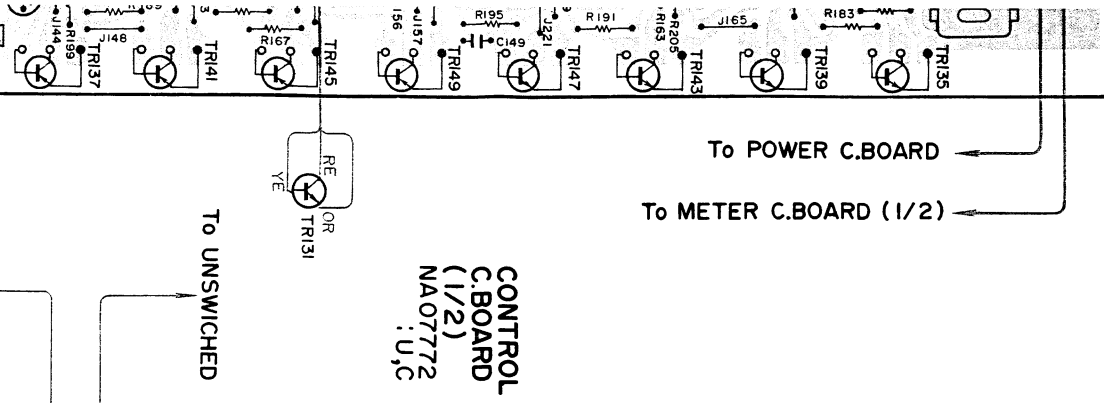

CONTROL C BOARD (2/2)

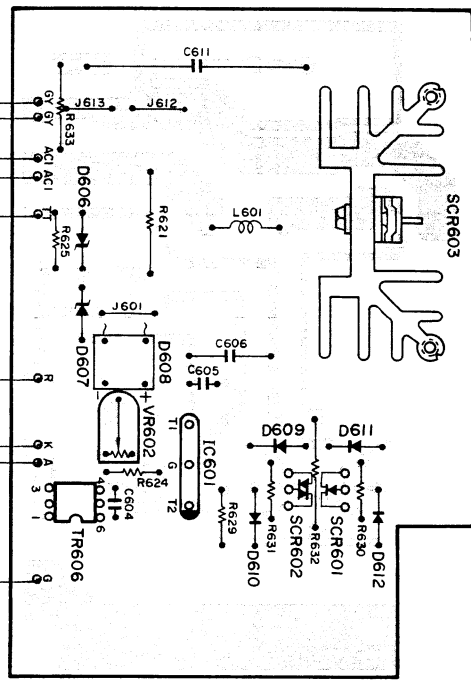

CONTROL C BOARD (1/2) NAO7772 :U,C

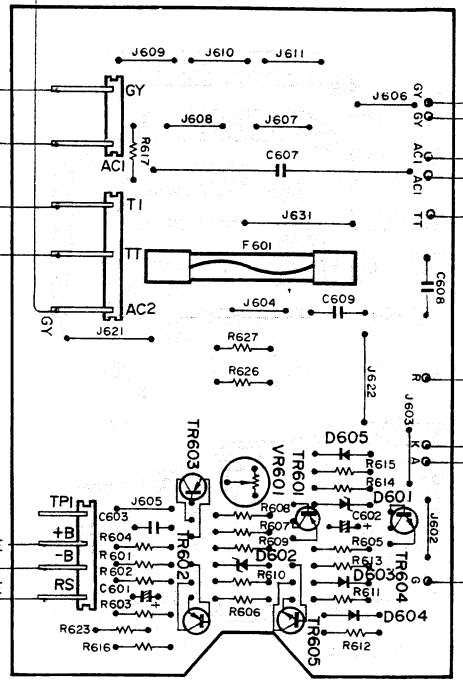

To UNSWITCHED

A,B,G-MODELS

CONTROL C BOARD (2/2)

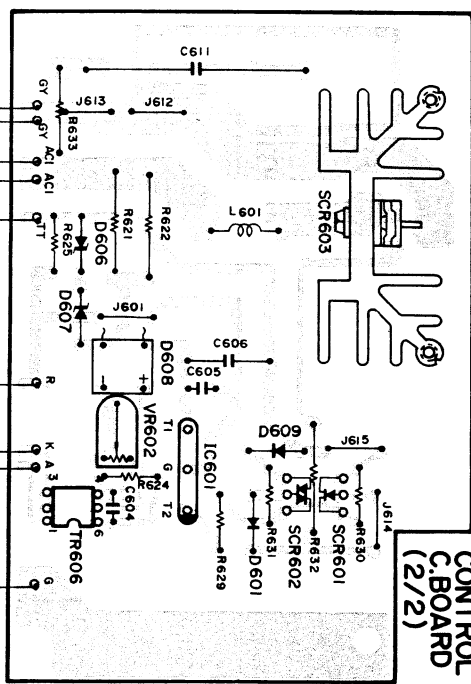

To AC CORD

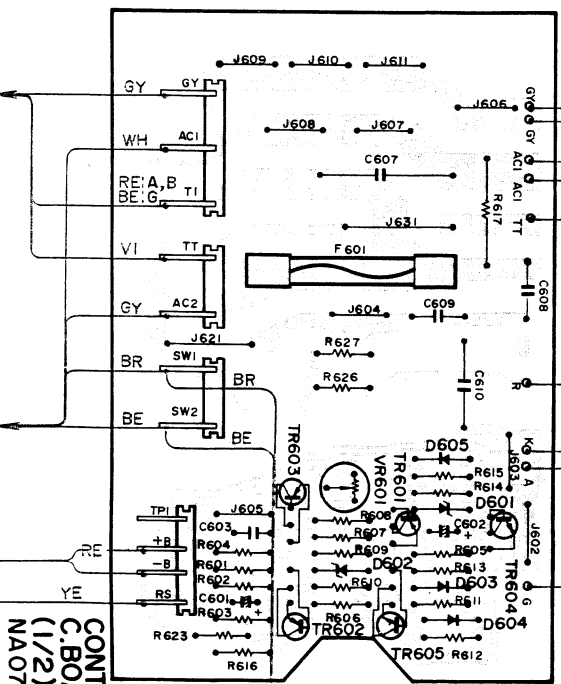

To POWER TRANSFORMER

To POWER SW

CONTROL C BOARD (1/2) NAO7773

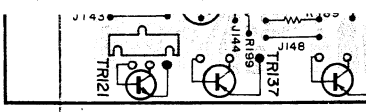

TO POWER SW
 TO TRANSFORMER
 TO MAIN C. BOARD
 TO CONTROL C. BOARD (1/2)

ELECTROLYTIC CAP C. BOARD (2/2)

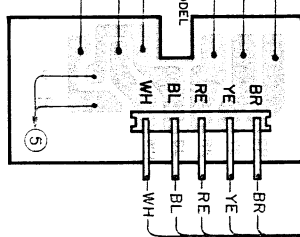

TO POWER C. BOARD

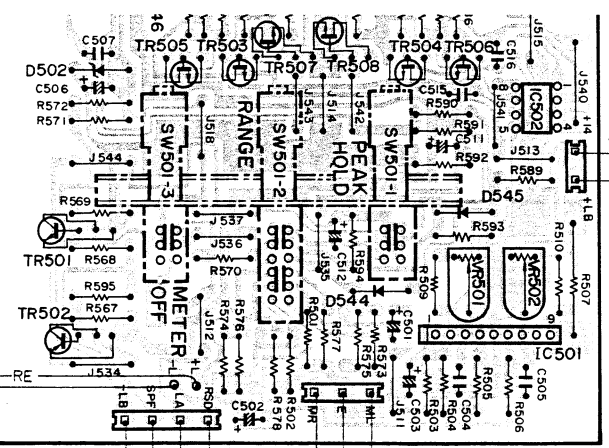

METER C. BOARD (2/2)

To MAIN C. BOARD

To METER C. BOARD (1/2)

**POWER C. BOARD NA07760:R
 NA07761:U,C
 NA07762:A,B,G**

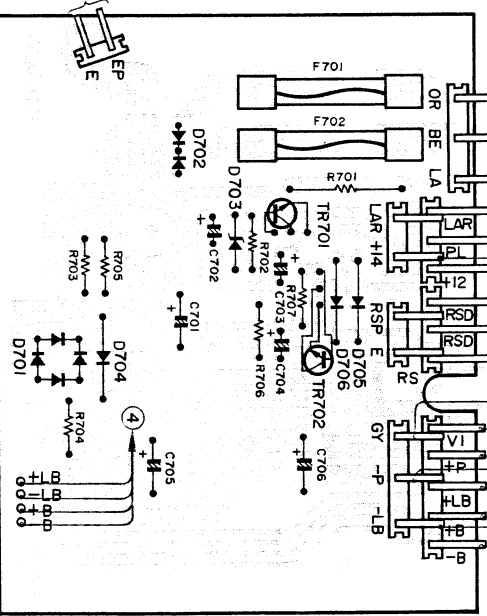

To POWER C. BOARD

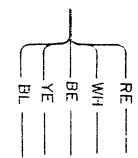

TO MAIN C. BOARD
 TO CONTROL C. BOARD (1/2)

TO POWER TRANSFORMER
 TO POWER SW

TO POWER SW
 TO POWER C. BOARD

TO POWER SW
 TO POWER C. BOARD

R-MODEL

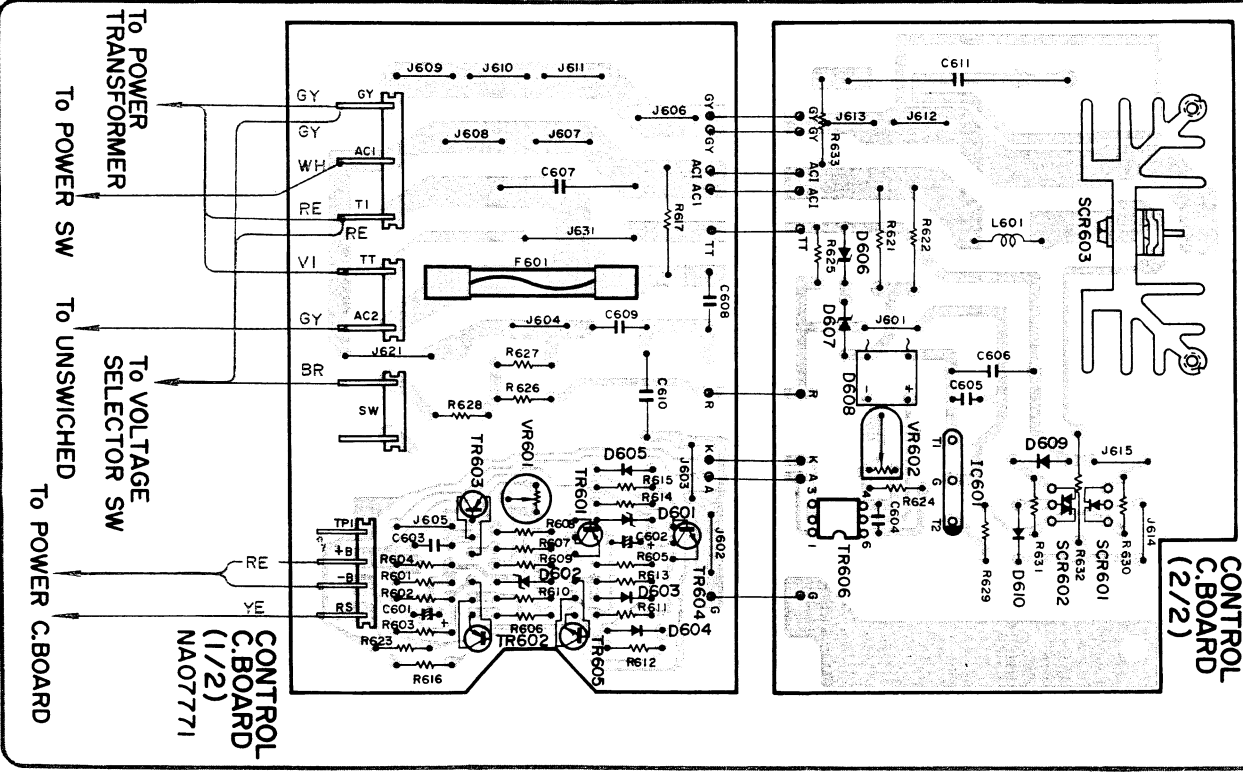

CONTROL C. BOARD (2/2)

CONTROL C. BOARD (1/2)
 NA07771

TO TRANSFORMER
 TO POWER SW
 TO VOLTAGE SELECTOR SW
 TO POWER C. BOARD

CONTROL C. BOARD (1/2)
 NA07773